

**Limited Liability Company <SpecTransContainer>**

**Tank-container T11-26KL**

**PASSPORT**

**T11-26,000 litre**

Reg.№ BBSU760000-760049

Model: NT/26/21

## ATTENTION TO THE VESSEL OWNER

1. The passport must remain in the vessel owner
2. Permission to operate the vessel shall be obtained in accordance with the Rules of industrial safety equipment operating under excessive pressure.
3. When transferring to another vessel owner with a vessel attached real passport
4. Copies Gospromnadzor permits derogation from the requirements of technical regulations shall be attached to the certificate of the vessel
5. The tank container is a finished product and requires no extra mounting

## 1. General information

Name and address of the manufacturer	Nantong Tank Container Co., Ltd 3888, Jintong highway, Tongzhou, Nantong, Jiangsu, China
Manufacture date	21.11.2018
Type	T11-26KL
Name and purpose	Tank container for safe transportation and temporary storage of liquid safe and dangerous goods assigned in accordance with UN classification to hazard class 3, 4.1, 4.2, 4.3, 5.1, 6.1, 8 and 9
Model	NT/26/21
Manufacture's №	02F169B218
Estimated cost of the vessel service	

## 2. Information about the technical specifications and parameters

Parameter Name	Value
1. Number UN instructions	UN T11
2. Nominal volume, liters	26,000
3. Maximum permissible gross mass, kg	36,000
4. Weight of the empty container (containers), kg	3,800
5. Maximum Capacity, kg	32200
6. Maximum Capacity in kg minimum permissible degree of filling,%	80
7. Maximum allowable density of the cargo at a temperature of 15°C and a degree of filling of the tank 80%, kg / l	1,55
8. Allowable weight of the upper container when stacked, kg	216000
9. Envelope according to ISO 668: 2013	1CC
10. Size and type code in ISO 6346: 1995 / Amd.33: 2012	22K2
11. Overall dimensions: - length - width - height	6058 <sub>.6</sub> 2438 <sub>.5</sub> 2591 <sub>.5</sub>
12. Distance between centers holes corner fittings, mm: - length - width	5853,5±4,5 2259±4
13. Difference of distances between the points of the projections of the axes diagonally opposite corner fittings, mm: - by the end walls - along the side walls - of the roof	10 13 13
14. The inner diameter of the tank, mm	2414
15. The nominal wall thickness of the cylindrical part of the tank, mm	4,4
16. The equivalent thickness of the cylindrical wall of the tank by soft steel not less than, mm	6,0

17. The nominal wall thickness of the tank bottoms, MPa	5,4
18. The maximum allowable working pressure, MPa	0,40
19. Design Pressure, MPa	0,40
20. Test pressure, MPa	0,60
21. Pressure relief valve starts opening, MPa	0,44
22. Complete pressure relief valve after tripping, MPa	0,40
23. Calculated external pressure, MPa	0,041
24. The pressure in the test tank at a density, MPa, not less than	0,1
25. The maximum vapor pressure in the heating system, MPa	0,40
26. Test pressure in the heating system, MPa	0,60
27. Calculated temperature, °C	+130
28. Maximum temperature of transported cargo, °C	+50
29. Operating temperature range, °C	-40 to +50
30. The minimum allowable negative wall temperature, °C	-40
31. Maximum temperature of the coolant, °C	+130
32. Name of the work environment	Liquid safe and dangerous goods hazard classes 3, 4.1, 4.2, 4.3, 5.1, 6.1, 8 and 9
33. Working environment group	1
34. Gain compensation for corrosion	0

### 3. Information about the basic elements of the tank-container

№	Container element designation	Number of units.	Dimensions, mm			Material		These welding			
			The diameter (inside)	The wall thickness (nominal)	Length (height)	Steel grade	TNPA	The process of the connection	Welding	Electrodes welding wire (type, grade, standards or specifications)	Method and volume control
1.	cylinder course	1	2414	4.4	4930	1.4402/ 1.4404	SANS 50028-7	GMAW		SFA- 5.9/SFA- 5.9M	ASME VIII Div.1 / EN14025
2.	Torospherical bottom, type C	2	2414	4.6	544	1.4402/ 1.4404	SANS 50028-7	GMAW		SFA- 5.9/SFA- 5.9M	ASME VIII Div.1 / EN14025
3.	Frame	1	-	-	6058* 2438* 2591	GB/T 1591 - Q345D	GB/T 1591 - Q345D	GMAW		SFA- 5.18/SFA- 5.18M	ISO1496-3
4.	Channel heating system	8	-	2.5	4577	JIS G4305 SUS 304	JIS G4305 SUS 304	GMAW		SFA- 5.9/SFA- 5.9M	ASME VIII Div.1 / EN14025

#### 4. Information about the fittings, covers, flanges with fastening parts (screws, bolts, nuts)

№	Name	Mark and designation, venture manufacturer	Amount	Main characteristics		Material	
				Name	Value	Steel grade	TNPA
1.	Flange mounting of the safety valve	S0604	1	Outside diameter, mm	215.9	316	
				Inner diameter, mm	82.5		
				Thickness, mm	27.5		
2.	Flange mounting top discharge provision	368/080S	1	Outside diameter, mm	200	316	
				Inner diameter, mm	95.3		
				Thickness, mm	26		
3.	Studs and fastening nuts for top discharge provision	312/1100	1	Thread, mm	6 x M12	304	
				The length of the stud, mm	43		
				Outside diameter, mm	200		
4.	Flange mounting bottom discharge device (pouring) load	324/9000	1	Inner diameter, mm	114.3	316	
				Thickness, mm	35.5		
				Thread, mm	8 x M12		
5.	Studs and fixing nuts bottom discharge device (pouring) load	324/2080	1	The length of the stud, mm	47,39,40	304	
				Outside diameter, mm	127		
				Inner diameter, mm	32		316
6.	Valve mounting flange of the gas (air) line	350/0025	1	Thickness, mm	23	304	
				Thread, mm	4xM10		
				The length of the stud, mm	38		
7.	Studs and nuts fastening the gas valve (air) line	350/1300	1	Outside diameter, mm	-	304	
				Inner diameter, mm	-		
				Thickness, mm	-		
8.	Flange mounting thermometer	None	-	Outside diameter, mm	-	-	
				Inner diameter, mm	-		
				Thickness, mm	-		

№	Name	Mark and designation, the manufacturer	Amount	Main characteristics		Material	
				Name	Value	Steel grade	TNPA
9.	thermometer tube	-	-	Outside diameter, mm			
				Inner diameter, mm			
				Thickness, mm			
10.	Flange mounting additional safety valve	None	-	Outside diameter, mm			
				Inner diameter, mm			
				Thickness, mm			
11.	Blind flange additional safety valve	None	-	Outside diameter, mm			
				Thickness, mm			
				Outside diameter, mm			
12.	Additional blind flange mounting	355/3100	2	Outside diameter, mm	165		
				Inner diameter, mm	48.8	316	
				Thickness, mm	31		
13.	Studs and stub flange nuts additional blind flanges	311/3050	2	Outside diameter, mm	4xM16		
				Full length, mm	60	304	
14.				-			
				-			
				-			

**5. Information about the safety devices, the main valve, measuring and control devices and safety devices**

№	Name	Mark and Designation, the manufacturer	Amount	Main characteristics		Design Pressure, MPa	Material	Installation site
				Name	Value			
1.	Manhole	Guard, R4583A01-00	1	Inner diameter, mm	500	0.4	316L	
2.	Safety valve	Guard, AMF48001-00	1	The pressure of full opening, MPa		0.44	CF8M	
				Test pressure, MPa				
3.	Valve gas (air) line	Guard, QKB04001-00	1	Orifice, mm	32		CF8M	
4.	Overflow device (pouring) load	None		Orifice, mm	-			
				The pressure of full opening, MPa	-			
5.	Manometer	None		The limit of measurement, MPa	-			
6.	Bottom drain device (pouring) load	Guard, HDJ48001-00	1	Orifice, mm	77		CF8M	
				The pressure of full opening, MPa	0.4			
7.	Thermometer		1	The limit of measurement? °C	-40~160			



## 6. Data on the hydraulic test

Container tank T11-26KL, factory № \_\_\_\_\_, subjected to external and internal inspection and tested for durability in a horizontal position within the container internal pressure water, equal 0.6 MPa at temperature 25 °C for 30 minutes.

The tank complies with the technical documentation requirements. Shut-off valves were installed during the hydraulic test:

- Manhole (finish writing)
- Etc

Tests made:

Operator (position)  
陆大峰 (signature)  
\_\_\_\_\_ (name)

Container after the test has taken:

QC (position)  
李建军 (signature)  
\_\_\_\_\_ (name)

### 7. Data on the hydraulic test

Container cargo heating system T11-26, factory № \_\_\_\_\_, subjected to visual inspection and tested for internal pressure strength of water, equal \_\_\_0.6\_\_\_ MPa at temperature \_\_\_25\_\_\_ °C for 15 minutes.

Heating system complies with the requirements of technical documentation.

Tests made:

Operator \_\_\_\_\_ (position)  
陈东林 \_\_\_\_\_ (signature)  
\_\_\_\_\_ (name)



Container after the test has taken:

O.C. \_\_\_\_\_ (position)  
\_\_\_\_\_ (signature)  
\_\_\_\_\_ (name)



## 8 Data on the pneumatic testing for leaks

Mounted on the container T11-26, factory № \_\_\_\_\_, safety, locking and test fixture tested for leaks in a horizontal position within the container by air pressure, equal 0.1 MPa at a temperature of 25 °C.

Shut-off valves were installed during the pneumatic test:

- Manhole (finish writing)
- Etc

Tank, mounted thereon shut-off and test valves and seals are tight-flanged connectors.

Tests made:

operator (position)  
张果果 (signature)  
\_\_\_\_\_ (name)

Container after the test has taken:

QC (position)  
周志军 (signature)  
\_\_\_\_\_ (name)

## 9. Manufacturer Conclusion

Based on inspections and tests certify that:

Tank container models T11-26 serial № BBSU760000-760049 manufactured in accordance with the requirements of technical regulations of the Customs Union "The safety of equipment operating under excessive pressure" (TP TC 032/2013), TY BY 791053861.001-2017, approved PC design documentation NT-26-21 and Rules PC making containers.

The container is fit to work with the specified parameters in this conclusion and the medium.

Qualified life 20 years old.

Chief Engineer (name of organization)

 (signature)  
南通四方罐式储运设备制造有限公司 (name)

Head of TCD (Technical Control Department)

 (signature)  
南通四方罐式储运设备制造有限公司 (name)

To a passport attached drawings general type tank container and the vessel.

A copy of the calculations of the capacity of the safety valve is given in one copy on the quantity of products.





## 12. Information about installed fixtures

Date of installation	Name	Amount	Nominal diameter, mm	Nominal pressure, MPa (kgs/cm <sup>2</sup> )	Material	Installation site	Painted face of the person responsible for the safe condition and safe operation of the vessel

Other vessel installation data:

1) corrosive environment \_\_\_\_\_

2) anticorrosive coating \_\_\_\_\_

3) thermal insulation -

**13. Information on the replacement and repair of the main elements of the pressure vessel and valves**

Date	Replacement and repair information	Painting of the person responsible for the condition of the condition and safety operation of the vessel



Date	Replacement and repair information	Painting of the person responsible for the condition of the condition and safety operation of the vessel

Date	Replacement and repair information	Painting of the person responsible for the condition of the condition and safety operation of the vessel

Date	Replacement and repair information	Painting of the person responsible for the condition of the condition and safety operation of the vessel

### 14. Record the results of the technical examination

Date of technical examination	Result of technical examination	Permissible pressure, MPa (kgs / cm <sup>2</sup> )	Period of the next technical examination

Date of technical examination	Result of technical examination	Permissible pressure, MPa (kgs / cm <sup>2</sup> )	Period of the next technical examination

Date of technical examination	Result of technical examination	Permissible pressure, MPa (kgs / cm <sup>2</sup> )	Period of the next technical examination

Date of technical examination	Result of technical examination	Permissible pressure, MPa (kgs / cm <sup>2</sup> )	Period of the next technical examination

Date of technical examination	Result of technical examination	Permissible pressure, MPa (kgs / cm <sup>2</sup> )	Period of the next technical examination



Date of technical examination	Result of technical examination	Permissible pressure, MPa (kgs / cm <sup>2</sup> )	Period of the next technical examination

Date of technical examination	Result of technical examination	Permissible pressure, MPa (kgs / cm <sup>2</sup> )	Period of the next technical examination

Date of technical examination	Result of technical examination	Permissible pressure, MPa (kgs / cm <sup>2</sup> )	Period of the next technical examination

Date of technical examination	Result of technical examination	Permissible pressure, MPa (kgs / cm <sup>2</sup> )	Period of the next technical examination

Date of technical examination	Result of technical examination	Permissible pressure, MPa (kgs / cm <sup>2</sup> )	Period of the next technical examination

Date of technical examination	Result of technical examination	Permissible pressure, MPa (kgs / cm <sup>2</sup> )	Period of the next technical examination

Date of technical examination	Result of technical examination	Permissible pressure, MPa (kgs / cm <sup>2</sup> )	Period of the next technical examination

Date of technical examination	Result of technical examination	Permissible pressure, MPa (kgs / cm <sup>2</sup> )	Period of the next technical examination



Date of technical examination	Result of technical examination	Permissible pressure, MPa (kgs / cm <sup>2</sup> )	Period of the next technical examination

Date of technical examination	Result of technical examination	Permissible pressure, MPa (kgs / cm <sup>2</sup> )	Period of the next technical examination

Date of technical examination	Result of technical examination	Permissible pressure, MPa (kgs / cm <sup>2</sup> )	Period of the next technical examination

Date of technical examination	Result of technical examination	Permissible pressure, MPa (kgs / cm <sup>2</sup> )	Period of the next technical examination

Date of technical examination	Result of technical examination	Permissible pressure, MPa (kgs / cm <sup>2</sup> )	Period of the next technical examination

Date of technical examination	Result of technical examination	Permissible pressure, MPa (kgs / cm <sup>2</sup> )	Period of the next technical examination

## 15. Vessel Registration

Tank container serial number №\_\_\_\_\_ has been registered as  
№\_\_\_\_\_ in \_\_\_\_\_ (Registering body)

In the passport numbered and laced up \_\_\_\_\_ pages.

\_\_\_\_\_ (Position registering entity)

\_\_\_\_\_ (Last name, first name, middle name (if any))

\_\_\_\_\_ (Signature)

20\_\_ (year) \_\_\_\_\_ (Month) \_\_\_\_\_ (day)

## 16. Warranty

Warranty periods of operation are calculated from the date of shipment of the container to the customer (consumer) if they comply with the conditions and rules for storage, transportation and operation established by the Operating Manual NT/26/21 and are established:

### **Indicate the year!**

On the tank –

On the metal structures of the power elements of the frame -

Body Insulation -

Heat insulation casing -

Safety valve, gas valve (airline), manhole, upper discharge device (loading) of the load, lower discharge device (loading) of the load, pressure gauge, thermometer -

Paints and varnishes -

Applications -

If defects in parts and assembly units appear during the warranty period, the representatives of the consumer and the manufacturer must, in accordance with the established procedure, draw up an act of complaint.

In accordance with the complaint act, the manufacturer must correct the defects or replace parts and assembly units as soon as technically possible, but no later than 20 days from the date of receipt of the act.

If the manufacturer refuses to eliminate defects, the customer reserves the right to send the container to the manufacturer or give the value for the previously paid products.



## 17. Certificate of acceptance of the container for use

Owner code \_\_\_\_\_

Number assigned by the owner of the container \_\_\_\_\_

Check number \_\_\_\_\_

Legal and postal address of the company owning the container

\_\_\_\_\_  
\_\_\_\_\_  
\_\_\_\_\_

Head of the company –

the owner of the container:

\_\_\_\_\_ (Signature)

\_\_\_\_\_ (Last name, first name, middle name (if any))

Head of the technical service of the enterprise –

the owner of the container:

\_\_\_\_\_ (Signature)

\_\_\_\_\_ (Last name, first name, middle name (if any))

Note:

The certificate is drawn up when the owner of the container changes, leases it or the operating organization (enterprise).

## Appendix B

### General view of the vessel

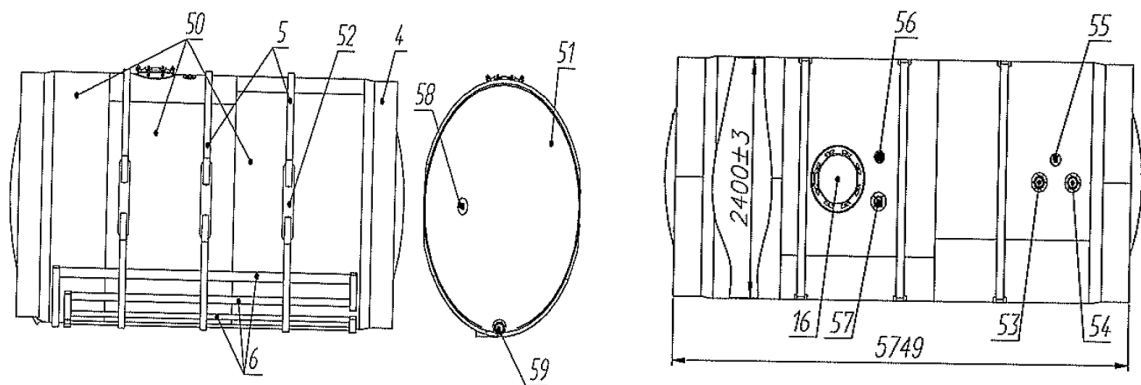

4 - Supporting shells attaching the tank to the end frames

5 - Pins (rings of stiffness)

6 - cargo heating system

16 - Luke

50 - Cylindrical shells

51 - Bottoms

52 - Base Sheets

53 - Flange mounting the upper device discharge (filling) of the goods

54 - Flange mounting additional top device drain (filling) of the goods (closed with a plug in the absence of an additional device)

55 - Flange mounting valve gas (air) line

56 - Flange mounting the main safety valve

57 - Flange mounting additional safety valve

58 - Thermometer mounting flange

59 - mounting flange of the lower load draining device

Figure B.1 - General view of the vessel

UN PORTABLE TANK T11  
IMDG - RID/ADR  
UN IMPACT TEST

22K2

XXXX XXXXXX X

MAX GROSS 38000KG  
TARE 3800KG  
CAPACITY 26000L  
MAWP 4BAR

26  
4  
Bar  
MAWP

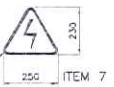

BLACK LETTERS/MARKINGS ON YELLOW (RAL 3033) BACKGROUND



MAXIMUM ALLOWABLE STEAM HEATING PRESSURE  
4 BAR

STEAM INLET

STEAM INLET

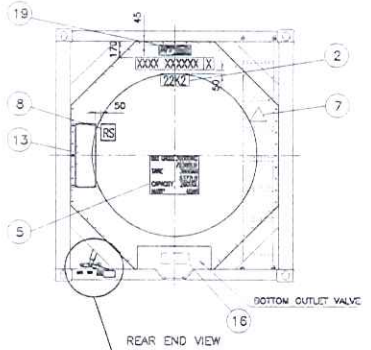
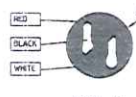
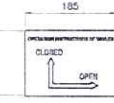

REAR END VIEW

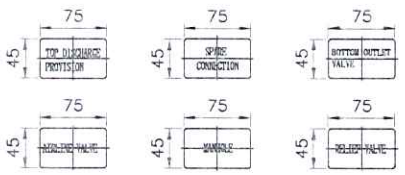
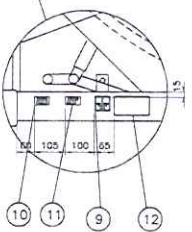

marking of fitting



ITEM 19

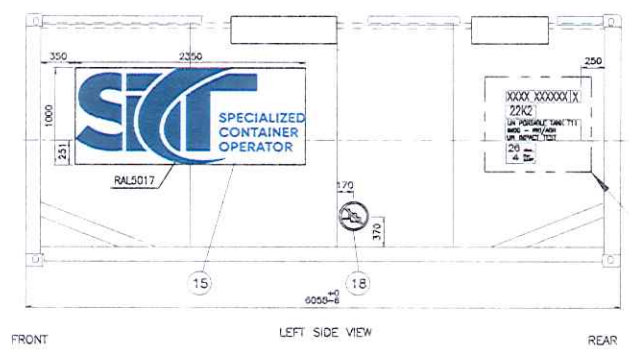

FRONT LEFT SIDE VIEW REAR

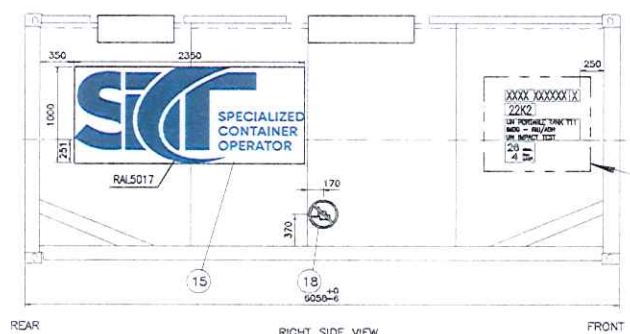

REAR RIGHT SIDE VIEW FRONT

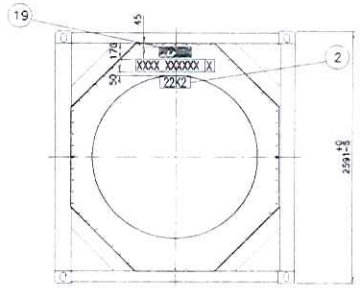

FRONT END VIEW

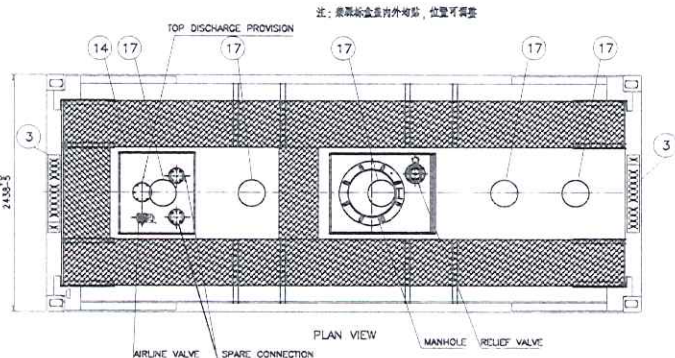

PLAN VIEW

注: 蒙票給盒蓋外相筋, 位置可調整

ITEM No.	DESCRIPTION
19	2 NTANK LOGO
18	2 NO Forklift
17	7 NO WALKING DECAL
16	1 OUTLET OPERATION INSTRUCTIONS
15	2 OWNER LOGO (WHITE BACKGROUND)
14	1 OPERATION INSTRUCTIONS OF VALVES
13	1 CONSOLIDATED DATA PLATE
12	1 MAXIMUM STEAM HEATING PRESSURE DECAL
11	1 STEAM INLET CONNECTION
10	1 STEAM OUTLET CONNECTION
9	1 EARTHING POINT
8	1 INSPECTION AUTHORITY LOGO
7	1 OVERHEAD ELECTRICAL POWER WARNING
6	2 CAPACITY & PRESSURE (80mm HIGH)
5	1 WEIGHT PANEL (70mm HIGH)
4	6 ISO CHECK NUMBER (100mm HIGH)
3	3 OWNER CODE AND SERIAL NUMBER (100mm HIGH)
2	2 SIZE AND TYPE CODE (100mm HIGH)
1	1 APPROVALS DECAL (70mm HIGH)

MARKINGS TO BE BLACK LETTERING AND WHITE BACKGROUND; ALL EXCEPTIONS TO THIS ARE NOTED ON DETAIL DRAWINGS



NANTONG TANK CONTAINER CO.,LTD

DO NOT SCALE. IF IN DOUBT, ASK

CUSTOMER	DRN. No.	DATE	2018.08.15	TITLE	26000L DECAL ASSEMBLY
JOB No.	CHKD. No.	DATE	2018.08.15		
CAD FILENAME	DRAWING No.				
26K Decals	NT / JW18195 / BT / 0				
REVISION	DATE	MODIFICATION	MOD. BY		

3888 JINTONG HIGHWAY, XINGREN TOWN, TONGZHOU CITY  
JIANGSU PROVINCE, P.R. CHINA